

***** To obtain manufacturer’s “Certificate-of-Compliance”, sump must be F-2 compliant. *****

Figure-2 compliance dictates that the distance between the top of the connection and the bottom of the grating cannot be less than 1.5 times the normal pipe diameter.

FITTING SCHEDULE					
FITTING	SIDE “A”	SIDE “B”	SIDE “C”	SIDE “D”	BOTTOM (SHOW ON PLAN VIEW)
1					
2					
3					
4					

INSTRUCTIONS: Indicate on the illustration, and on the fitting schedule, the location and size of the desired fitting(s). (NOTE: Represent one sump per worksheet)

All sumps to be made of 3 layers of 1-1/2 oz fiberglass. All fittings to be placed 1” above the bottom of the fittings unless otherwise specified. The female adapters at the bottom shall be centered unless otherwise specified and located 7-5/8” from each end. All fittings are installed flush with the inside of the sump body unless specified otherwise. Also, unless specified otherwise, all side fittings are to be female adapters up to 8”. Above 8”Ø fittings are to be Class 125 PVC couplings. Please note that top grate **CANNOT** protrude above the top edge of the sump.

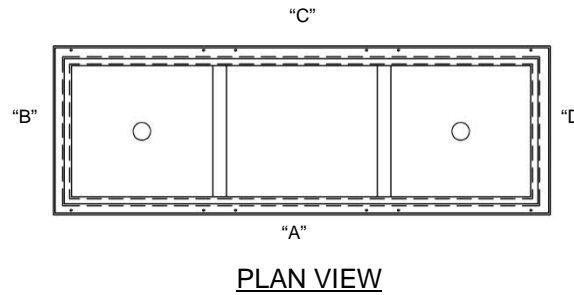
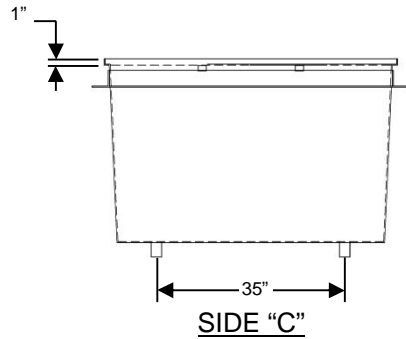

**18”W X 54”L X 34”H
FIBERGLASS SUMP**
(PART NUMBER: FI-SG-185434-PK)

ANSI/APSP/ICC-16 2017

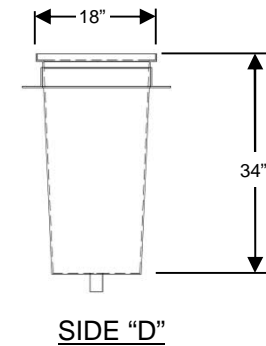
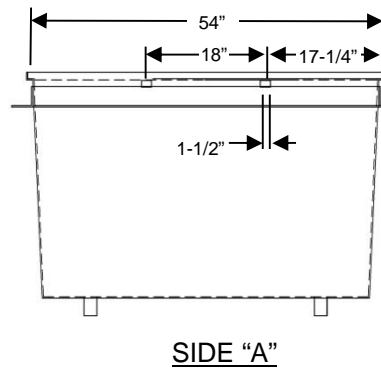
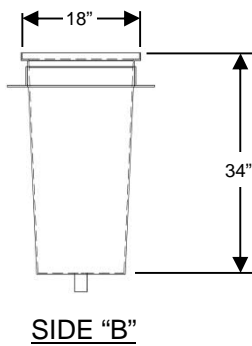

R 7/11/22